

## Frame for device inserts with 55 × 55 mm fitting dimensions

### How energy efficiency is improved

The new room operating units of the SAUTER EY-modulo 2 ecos and EY-modulo 5 ecos families of devices, as well as the EGT 33\* and viaSens room sensors enable fitting in standard frames from a variety of light switch manufacturers due to their standard installation dimension of 55 x 55 mm. The frame can be selected for the surface or recessed fitting method, as well as for its colour and design. In this way, the SAUTER devices can be matched to the architecture and the individual design requirements for the room while also contributing to maximum energy efficiency in the room control.

### Features

- Accessory components for SAUTER device inserts with 55 × 55 mm aperture
- Suitable for ecoUnit 1 room operating units EY-RU 1\*\* and EY-SU 106
- Suitable for ecoUnit 2 room operating units EY-RU2\*\*
- Suitable for ecoUnit 3 room operating units EY-RU 3\*\* and EY-SU 306
- Suitable for EGT 33\* room sensors
- Suitable for viaSens room sensors
- Adhesive plate for smooth surfaces
- Surface and recessed mounting
- Adaptation to the GIRA series: Standard55, E2, Event, Esprit
- Adaptation to the Jung series: LS990, A500, A plus, A Creation, CD500
- Adaptation to the MERTEN series: M-smart, ARTEC, M-Plan, M-ARC
- Adaptation to the Busch-Jaeger series: Future, Future linear
- Adaptation to the Berker series: B.1
- Adaptation to the Feller series: EDIZIOdue



EY-RU 346, EY-SU 306

### Accessories

#### Mounting plate

Type	Description
0940240703	Mounting plate, single, for recessed fitting (10 pcs.)
0940240704	Mounting plate, single, type 2, for recessed fitting (10 pcs.)
0940240802	Mounting plate, double, for recessed fitting (10 pcs.)

#### Frames for recessed mounting

Type	Description
0940240102	Frame, single, pure white, RAL 9010 (10 pcs.)
0940240202	Frame, double, pure white, RAL 9010 (10 pcs.)

#### Frames for surface mounting

Type	Description
0940240301	Baseplate, single (for wall mounting), 10 pcs.
0940240401	Baseplate, double (for wall mounting), 10 pcs.
0940240501	Cable plate, single (for surface-mounted wiring), 10 pcs.
0940240601	Cable plate, double (for surface-mounted wiring), 10 pcs.
0940240710	Adhesive plate, single, black, 83 × 83 mm, 10 pcs.
0940240711	Adhesive plate, double, black, 83 × 143 mm, 10 pcs.

#### Spacer frames for adapting non-SAUTER frames

Type	Description
0940240751	Spacer frame, 0.5 mm (10 pcs.)
0940240752	Spacer frame, 1.0 mm (10 pcs.)
0940240753	Spacer frame, 1.5 mm (10 pcs.)
0940240755	Spacer frame, F1 (10 pcs.)



**Recessed mounting with SAUTER frame**

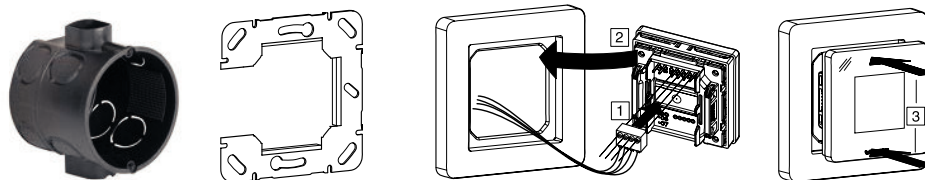

(1) (2) (3) (4)

- (1) Recessed junction box
- (2) Mounting plate
- (3) Frame
- (4) Device insert

**Surface mounting with SAUTER frame**

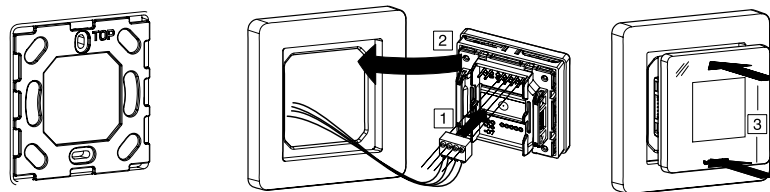







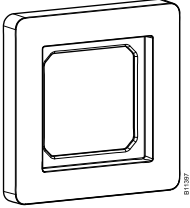

(1) (2) (3)

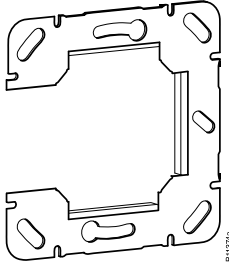
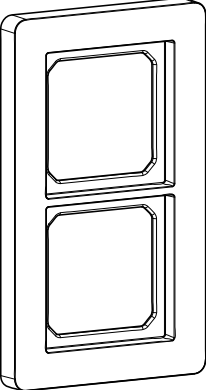
- (1) Optional cable cover plate
- (2) Baseplate including surface mounting plate
- (3) Device insert

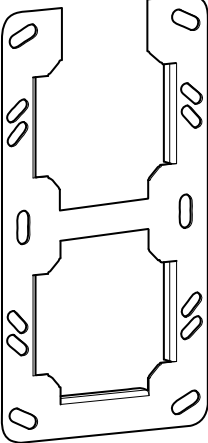
**Single and double frames**

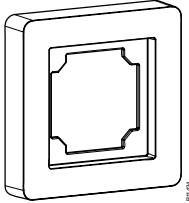
The SAUTER surface and recessed frames are available as single and double versions. The frames available are listed below with the parts required for installation.

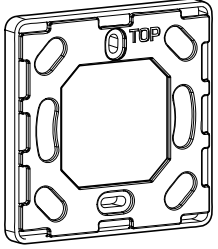
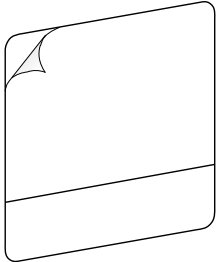
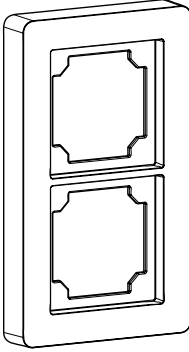
Fitting	Frame	Example with device insert	Fitting parts
Recessed mounting	<p>Single frame: 0940240102</p>  <p style="text-align: right; font-size: small;">811299</p>	<p>Single frame with EY-RU 346</p> 	<p>Single mounting plate: 0940240703</p>  <p style="text-align: right; font-size: small;">811294</p>
	<p>Double frame: 0940240202</p>  <p style="text-align: right; font-size: small;">811398</p>	<p>Double frame with EY-RU 346</p> 	<p>Double mounting plate: 0940240802</p>  <p style="text-align: right; font-size: small;">811368a</p>

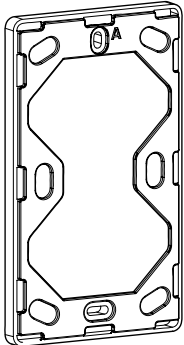
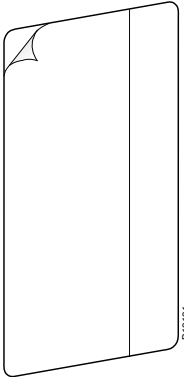
Fitting	Frame	Example with device insert	Fitting parts
Surface	<p>Single baseplate: 0940240301</p> 	<p>Single baseplate with EY-RU 346</p> 	<p>For surface-mounted cable feed, single cable cover plate: 0940240501</p>  <p>For fitting on smooth surfaces (e.g. glass), single adhesive plate: 0940240710</p> 
	<p>Double baseplate: 0940240401</p> 	<p>Double baseplate with EY-RU 346</p> 	<p>For surface-mounted cable feed, double cable cover plate: 0940240601</p>  <p>For fitting on smooth surfaces (e.g. glass), double adhesive plate: 0940240711</p> 

**Using non-SAUTER frames**

Many light switch manufacturers supply frames for the standard installation dimension of 55 x 55 mm for SAUTER device inserts. Listed below is a selection of non-SAUTER frames that have been checked for compatibility with SAUTER device inserts. The height of the non-SAUTER frame is also decisive for the fit as well as the installation opening of 55 x 55 mm.

**Please note**

- This document lists the compatible product ranges of light switch manufacturers. The product ranges are available in various colours and materials. Single, double and sometimes multiple frames are

generally available. You can obtain further information from the light switch manufacturer directly via the internet. The colours shown for the individual frames are just some examples of the numerous options available.

- The frames listed in this document have been checked to ensure perfect mechanical compatibility for SAUTER device inserts. Product series that are not listed here, or products from other manufacturers, can be checked for compatibility by SAUTER on request.
- Non-SAUTER frames can be obtained from the respective manufacturer's dealers. The regional representatives and distributors can be found on the website of the light switch manufacturer.
- Service offer from SAUTER-Cumulus GmbH, Freiburg, Purchasing department: SAUTER-Cumulus has agreed on some purchasing conditions with German light switch manufacturers. For orders of more than 100 frames, you can receive an alternative offer to the local supplier from SAUTER-Cumulus.

**Components for a non-SAUTER frame adaptation**

The new ecoUnits and EGT room operating units have an edge dimension of 55x55 mm. They fit directly into frames from a variety of light switch manufacturers.

Depending on the manufacturer in question, a special spacer frame (and in some cases a special mounting plate) is required for the adaptation to compensate for the different frame heights.

**A total of four components are used for this purpose:**

- (1) Mounting plate
- (2) Non-SAUTER frame
- (3) Spacer frame
- (4) Device insert to be mounted, e.g. EY-RU3\*\*....

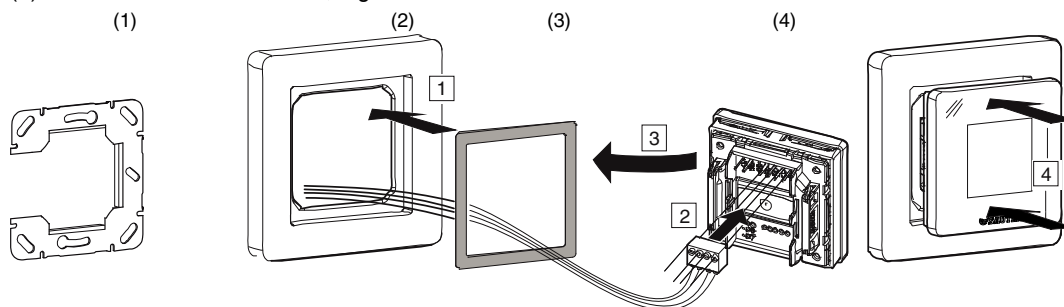

**Adaptation accessories:**



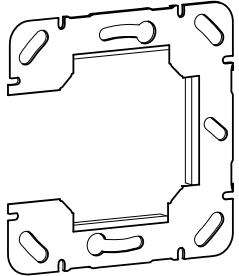
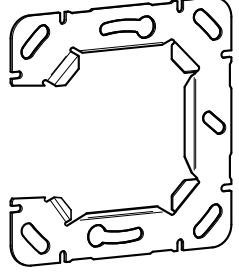
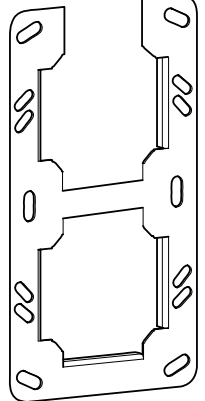



Accessory number	Designation	
0940240751	Spacer frame 0.5 mm	
0940240752	Spacer frame 1.0 mm	
0940240753	Spacer frame 1.5 mm	
0940240755	Spacer frame, F1	



Accessory number	Designation	
0940240703	Single mounting plate	
0940240704	Single mounting plate, type 2	
0940240802	Double mounting plate	

 The frames of the various manufacturers are suitable for recessed mounting. For some series, additional adaptors are available for surface mounting. For surface mounting, all parts of the recessed mounting are required, i.e. a standard frame, the appropriate mounting plate and a spacer frame if necessary (see table below), as well as the surface adaptor.

## GIRA

*i* Internet address of the manufacturer: [www.gira.de](http://www.gira.de)

Series	Sample illustration	Frame	Adaptation accessories from SAUTER
Standard 55			Single mounting plate 0940240703  1.5 mm spacer frame 0940240753
Surface adaptor for series: Standard 55		Gira no. 0219 0*1) height approx. 15 mm 	
E2			Single mounting plate 0940240703  0.5 mm spacer frame 0940240751
Event			Single mounting plate 0940240703  0.5 mm spacer frame 0940240751

Series	Sample illustration	Frame	Adaptation accessories from SAUTER
Esprit			Single mounting plate 0940240703  0.5 mm spacer frame 0940240751
Surface adaptor for series: E2, Event, Esprit		Gira no. 0219 2 <sup>1)</sup> Height approx. 15 mm 	

For a multiple frame, the corresponding number of single mounting plates must be fitted.

**JUNG**



*i* Internet address of the manufacturer: [www.jung.de](http://www.jung.de)

Series	Example illustrations	JUNG frame (D)	Adaptation accessories from SAUTER
LS 990		(frame + intermediate frame) 	Single mounting plate, type 2 094024070  1.0 mm spacer frame 0940240752
Surface box for series: LS990		Single/double Jung no.: LS 581A / LS 582A Height approx. 47 mm 	

<sup>1)</sup> Gira's colour number must be added.







Series	Example illustrations	JUNG frame (D)	Adaptation accessories from SAUTER
A 500			Single mounting plate 0940240703  1.0 mm spacer frame 0940240752
Surface box for series: A500		Single/double Jung no.: AS 581A / AS 582A Height approx. 47 mm  	
CD500		Frame in colour of choice (e.g. CD581PT); Additionally: intermediate frame 561 Z5 (white)  	Single mounting plate, type 2 0940240704  1.0 mm spacer frame 0940240752
Surface box for series CD500		Jung no.: CD581A** Height approx. 47 mm  	

Series	Example illustrations	JUNG frame (D)	Adaptation accessories from SAUTER
A plus			Single mounting plate 0940240703  1.0 mm spacer frame 0940240752
A Creation (AC581)			Single mounting plate 0940240703  1.0 mm spacer frame 0940240752

For a multiple frame, the corresponding number of single mounting plates must be fitted.

**MERTEN**

*i* Internet address of the manufacturer: [www.merten.de](http://www.merten.de)





Series	Sample illustration	MERTEN frame (D)	Adaptation accessories from SAUTER
M-Smart			Single mounting plate 0940240703  No spacer frame
ARTEC			Single mounting plate 0940240703  1.0 mm spacer frame 0940240752

Series	Sample illustration	MERTEN frame (D)	Adaptation accessories from SAUTER
Surface adapter for series M-Smart ARTEC		Single/double Merten no.: 5121** / 5122** Height approx. 31 mm 	
M-Plan			2 each :Single mounting plate 0940240703  0.5 mm spacer frame 0940240751
M-ARC			2 each :Single mounting plate 0940240703  1.0 mm spacer frame 0940240752

For a multiple frame, the corresponding number of single mounting plates must be fitted.

**Manufacturer Busch-Jaeger**

*i* Internet address of the manufacturer: [www.busch-jaeger.de](http://www.busch-jaeger.de)

Series	Sample illustration	Busch-Jaeger frame (D)	Adaptation accessories from SAUTER
Future		Frame + intermediate frame 	Single mounting plate 0940240703  1.0 mm spacer frame 0940240752
Future linear		  One frame (Busch-Jaeger item: 172* -*) is required, plus an intermediate frame: 1747-8* N.B. Not available in every colour)	Single mounting plate 0940240703  1.0 mm spacer frame 0940240752
Surface adapter for series: Future linear		Single/double Busch-Jaeger no.: 1701-8* / 1702-8* Height approx. 43 mm 	

For a multiple frame, the corresponding number of single mounting plates must be fitted.

**Berker**

*i* Internet address of the manufacturer: [www.berker.de](http://www.berker.de)

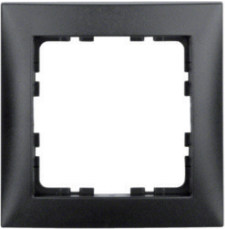

Series	Sample illustration	Berker frame (D)	Adaptation accessories from SAUTER
S.1		Frame 	Single mounting plate 0940240703  1.0 mm spacer frame 0940240752

For a multiple frame, the corresponding number of single mounting plates must be fitted.

The following series from Berker cannot be used because the opening dimensions do not match: K.1, K.5

### Manufacturer Feller

*i* Internet address of the manufacturer: [www.feller.ch](http://www.feller.ch)

Series	Sample illustration	Feller frame (CH)	Adaptation accessories from SAUTER
EDIZIOdue			<p>Single mounting plate 0940240703</p> <p>Spacer frame F1 0940240755</p> <p>Double mounting plate 0940240802</p> <p>Spacer frame F1 (2 pcs.) 0940240755</p>
Surface box for series: EDITIOdue		<p>Single/double Feller type: FX.39 Height approx. 39 mm</p> 	

 Only single and double frames are possible with Feller products.

### Other brands

The following programme lines are not suitable, because the opening dimensions are not the standard 55 x 55 mm:

- Manufacturer Legrand: Mosaic, Soliroc, Galea, Creo, Niloe, Oteo, Living-Light
- Manufacturer Bticino: Axolute

Dimension drawings

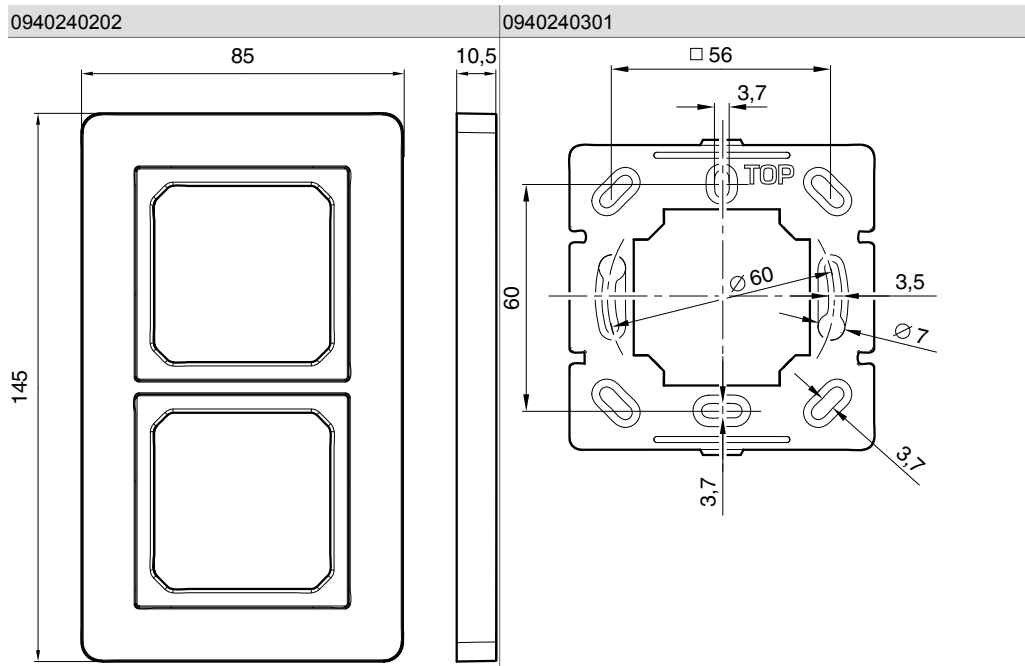
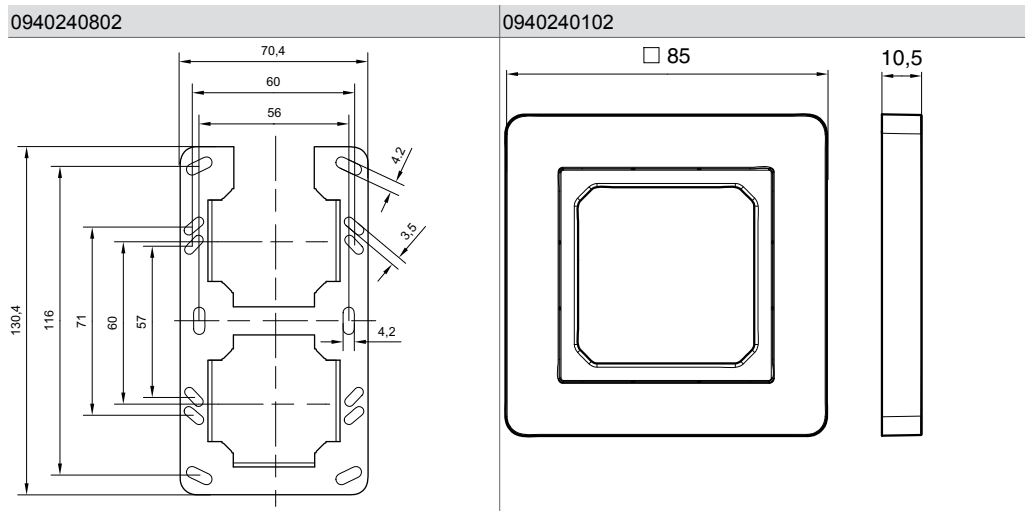
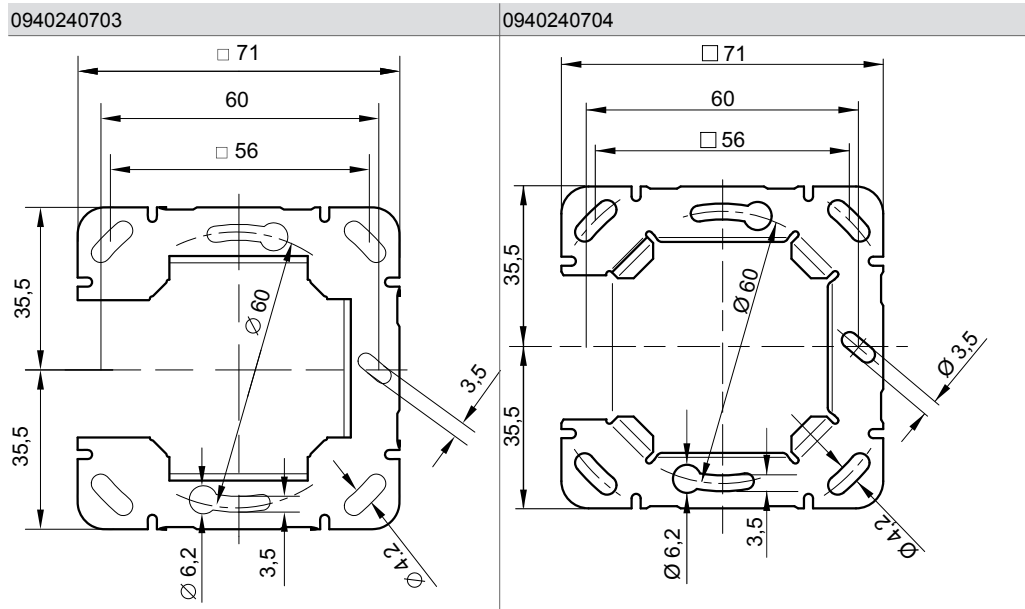

0940240401

0940240501

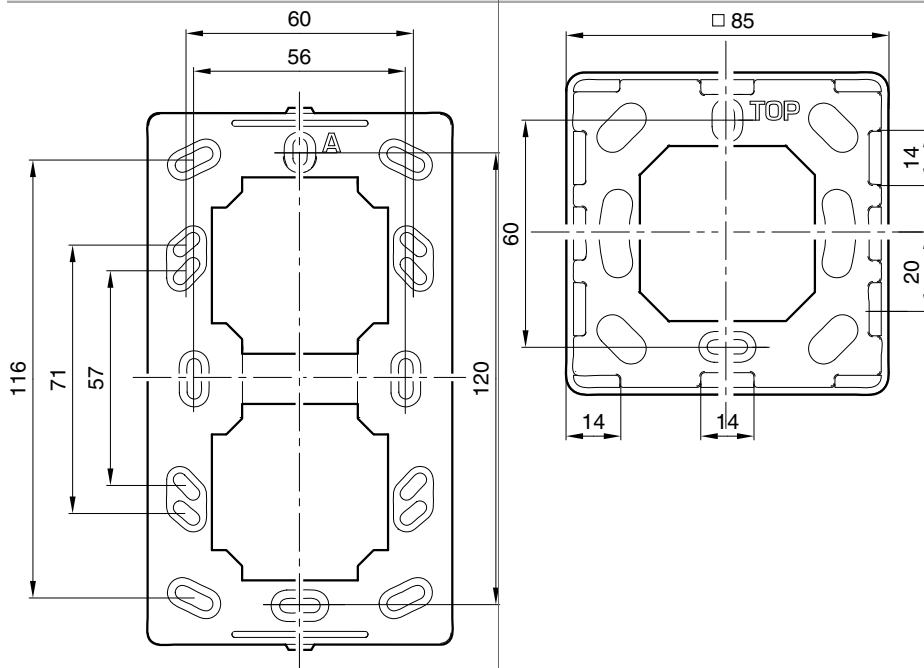

0940240601

